

# KOMATSU

## PC88MR-10

EPA Tier 4 Final Engine

Australia & New Zealand Specifications

HYDRAULIC EXCAVATOR



The photo shows Japanese specification.

### HORSEPOWER

Gross:  
50.7 kW 68.0 HP / 1950 min-1  
Net:  
48.8 kW 65.5 HP / 1950 min-1

### OPERATING WEIGHT

8,500 - 8,750 kg

### BUCKET CAPACITY

0.09 - 0.34 m<sup>3</sup>

# PC88MR

# WALK-AROUND

**Introducing the environmentally friendly next generation compact hydraulic excavator.**

**Compliant with EPA Tier 4 Final emissions regulations.**

## **ECOLOGY & ECONOMY**

- Low emission engine – A powerful turbocharged and air-to-air aftercooled Komatsu SAA4D95LE-6 engine provides 48.8 kW 65.5 HP. This engine is EPA Tier 4 Final and EU Stage 3B emissions certified, without sacrificing power or machine productivity.
- Low operation noise – The dynamic noise is reduced providing low noise operation.
- Drastic improvement in efficiency, effective in various work sites – See pages 4 and 5.

## **PRODUCTIVITY FEATURES**

**Komatsu's new engine technology includes:**

- Fuel-saving technology – PC88MR-10 introduces new engine and hydraulic pump control technology. See pages 4 and 5.
- Small tail swing – See page 6.
- Mode selection – Six working modes designed to match engine speed, pump delivery and system pressure.
- High mobility – See page 6.
- Large comfortable cab – Auxiliary input jack. See page 7.

## **SAFETY**

- Lock lever auto lock function
- Seat belt caution indicator
- Engine shutdown secondary switch  
See pages 8 and 9.

## **EASY MAINTENANCE**

- Replacement of fuel filter from ground
- Fan belt auto-tensioner
- Battery disconnect switch

## **KOMTRAX**

- Equipment management support
- Energy-saving operation support report

## **INFORMATION & COMMUNICATION TECHNOLOGY (ICT)**

- Large multi-lingual high resolution LCD monitor
- Supports efficiency improvement
- Equipped with the EMMS monitoring system





The photo shows Japanese specification.

**HORSEPOWER**

Gross:  
50.7 kW 68.0 HP / 1950 min-1  
Net:  
48.8 kW 65.5 HP / 1950 min-1

**OPERATING WEIGHT**

8,500 - 8,750 kg

**BUCKET CAPACITY**

0.09 - 0.34 m<sup>3</sup>

# PRODUCTIVITY & ECOLOGY FEATURES

## ENVIRONMENT-FRIENDLY ENGINE

The Komatsu SAA4D95LE-6 engine is EPA Tier 4 Final and EU Stage 3B emissions certified and provides exceptional performance while reducing fuel consumption. Based on Komatsu proprietary technologies developed over many years, this new diesel engine reduces exhaust gas particulate matter (PM) by more than 90% and nitrogen oxides (NOx) by more than 15% when compared to Tier 4 Interim levels. Through the in-house development and production of engines, electronics, and hydraulic components, Komatsu has achieved great advancements in technology, providing high levels of performance and efficiency in virtually all applications.

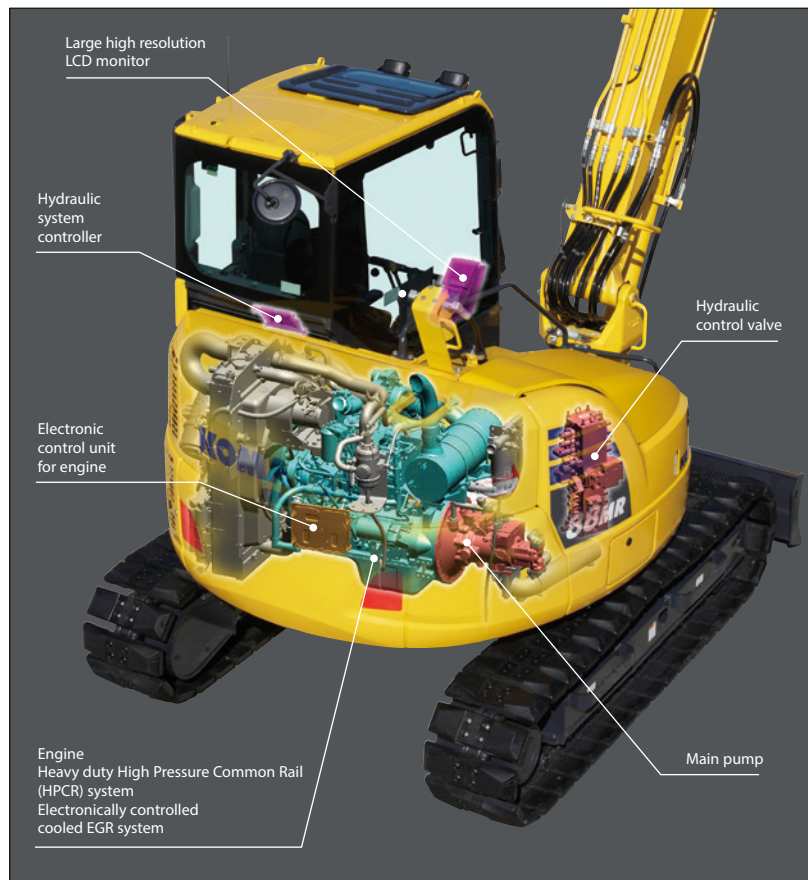
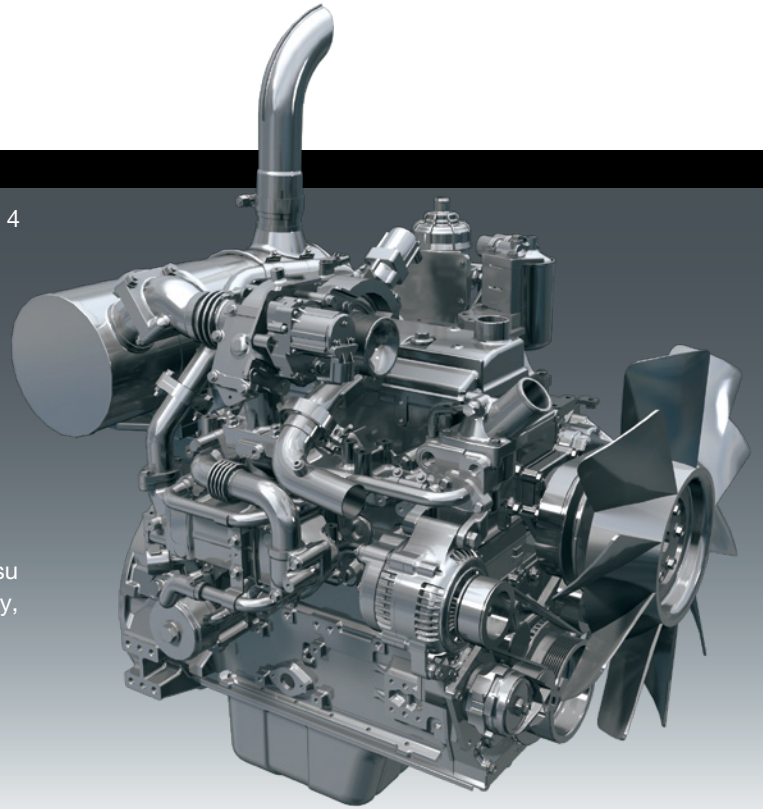

## Efficient Hydraulic System

The PC88MR-10 uses a Closed-centre Load Sensing System (CLSS) that improves fuel efficiency and provides quick response to the operator's demands.

The PC88MR-10 also introduces new technology to enhance the engine and hydraulic pump control. This total control system matches the engine and hydraulics at the most efficient point under any load condition. There have also been improvements in the main valve and hydraulic circuit to reduce hydraulic loss, resulting in higher efficiency and lower fuel consumption.

Reduced up to

**4%** fuel consumption

vs PC88MR-8  
Based on typical work pattern collected via KOMTRAX. The fuel consumption reduction may be less than the above value during actual work, depending on the contents of the work.

### Komatsu's New Engine Technology Includes Variable Flow Turbocharger (VFT)

A newly designed variable flow turbocharger features simple and reliable technology that varies the intake air flow. Exhaust turbine wheel speed is controlled by flow control valve and it enables to deliver optimum air quantity to the engine combustion chamber under all speed and load conditions. The result is cleaner exhaust gas while maintaining power and performance.

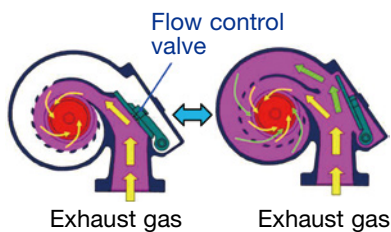

### Cooled Exhaust Gas Recirculation (EGR)

Cooled EGR, a technology well-proven in existing Komatsu engines, reduces NOx emissions. These components ensure reliable performance during the demanding work conditions of construction equipment.

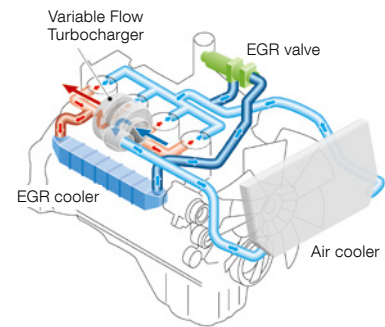

### Komatsu Diesel Oxidation Catalyst (KDOC)

Komatsu has designed and developed a simple and high efficiency diesel oxidation catalyst. This system enables to eliminate the need of the PM regeneration and to simplify the engine control system. High performance exhaust noise silencer is also integrated and it contributes the engine noise reduction.

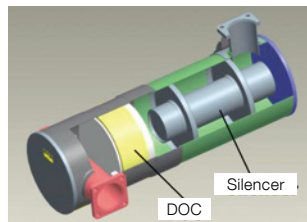

### Redesigned Combustion Chamber

The combustion chamber located at the top of the engine piston has a new shape designed to improve combustion and further reduce NOx, PM, fuel consumption, and noise levels.

### Komatsu Closed Crankcase Ventilation (KCCV)

Crankcase emissions (blowby gas) are passed through a CCV filter. The CCV filter traps oil mist which is returned back to the crankcase while the gas, which is almost oil mist free, is fed back to the air intake.



### Heavy Duty High Pressure Common Rail (HPCR) Fuel Injection System

Computer controlled heavy duty HPCR system delivers a precise quantity of pressurised fuel into the engine combustion chamber using multiple injections to achieve complete fuel burn and reduce exhaust emissions. Fuel injector reliability has been improved through the use of ultra-hard wear resistant materials such as diamond-like carbon.

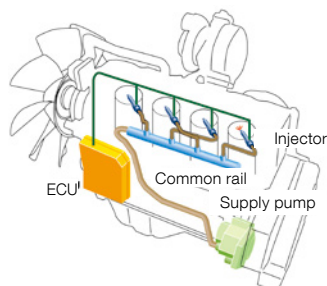

### Newly Designed 16 Valve Cylinder Head

Komatsu has designed and developed a new 16 valve cylinder head. It enables to reduce exhaust emissions by maximised air intake quantity and optimised fuel combustion.

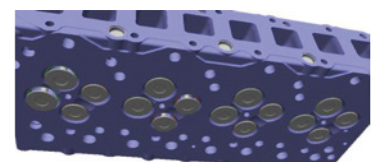

### Electronically Controlled Common Rail Type Engine

- Multi-staged injection
- Low Noise Design
- Optimal arrangement of sound absorbing materials
- Partition between the cab and engine room
- Airtight valve room

# PRODUCTIVITY & ECOLOGY FEATURES

## Advantage even in Confined Job Site

### Small Tail Swing

The narrow swing area is well suited for operation in confined areas with only a 325 mm protrusion over the tracks.

#### Roadwork

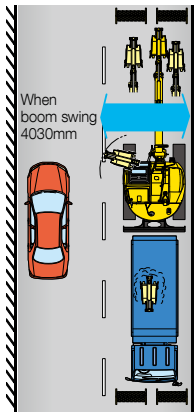

#### Logging and Forest Roadwork

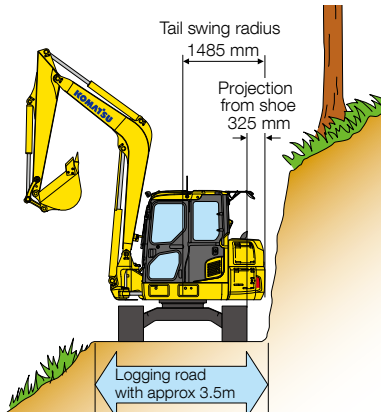

### Against Wall

PC88MR-10 can efficiently work in confined spaces with its swing boom design.



### High Mobility

The PC88MR-10's exceptional travel performance comes from high drawbar pull and single pump with double flow. It demonstrates superb maneuverability while operating at its optimum travel speed. It exhibits a large drawbar pull for mobility on job sites, traveling in rough terrain and climbing steep slopes.

Maximum drawbar pull: 66.9 kN 6820 kg

### Swing Performance

Powerful swing force on slopes.

### Auto-deceleration

Engine speed automatically slows down when all control levers are set in neutral to minimise fuel consumption.

### Two Automatic Travel Speeds

High or low—whichever speed suits the ground and job conditions—can be selected with one touch. As terrain changes, travel speed will automatically shift up or down within the selected speed range.

### Working Modes Selectable

The PC88MR-10 excavator is equipped with six working modes (P, E, L, B and ATT mode). Each mode is designed to match engine speed and pump speed with the current application. This provides the flexibility to match equipment performance to the job at hand.

Working Mode	Application	Advantage
<b>P</b>	Power mode	<ul style="list-style-type: none"> <li>• Maximum production/power</li> <li>• Fast cycle times</li> </ul>
<b>E</b>	Economy mode	<ul style="list-style-type: none"> <li>• Good cycle times</li> <li>• Better fuel economy</li> </ul>
<b>L</b>	Lifting mode	<ul style="list-style-type: none"> <li>• Increases hydraulic pressure</li> </ul>
<b>B</b>	Breaker mode	<ul style="list-style-type: none"> <li>• Optimum engine rpm, hydraulic flow</li> </ul>
<b>*ATT/P or ATT/E</b>	Attachment Power mode	<ul style="list-style-type: none"> <li>• Optimum engine rpm, hydraulic flow, 2-way</li> </ul>

\*: it is possible to set ATT/P mode or ATT/E mode.

**ATT/P** Power mode for attachment mode

**ATT/E** Economy mode for attachment mode

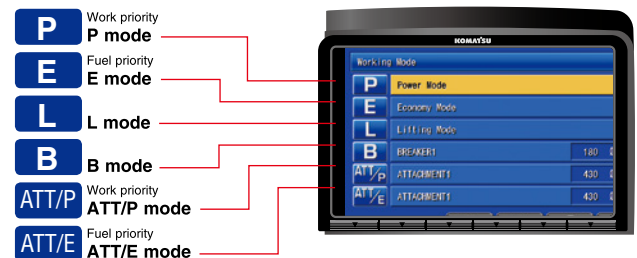

### ECO-Gauge Assists with Energy Saving Operations

The ECO-gauge and new fuel consumption gauge are viewed on the right side of the colour monitor and assist the operator in maintaining low fuel consumption and environment friendly operation.

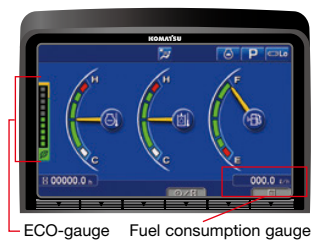

ECO-gauge Fuel consumption gauge

### Idling Caution

To prevent unnecessary fuel consumption, an idling caution is displayed on the monitor, if the engine idles for 5 minutes or more.



### Auto Idle Stop Function

When the engine has been idling for a certain time, the engine stops automatically to reduce unnecessary fuel consumption and exhaust emissions. The duration before the engine shutdown can be easily programmed.



# WORKING ENVIRONMENT



## Low Cab Noise

Cab is highly rigid and has excellent sound absorption ability. Through improvement of noise source reduction and use of low noise engine, hydraulic equipment, and air conditioner allows this machine to generate a low level of noise.

## Sliding Convex Door

The sliding convex door facilitates easy entrance and exit in confined areas.

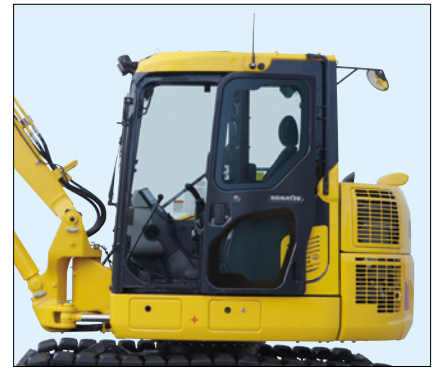

## Large Cab

Large cab provides ample operation space. The cab has a wide doorway for easy access.



## Automatic Air Conditioner

The automatic air conditioner allows the operator to easily and precisely set the cab temperature using the large LCD colour monitor panel. The bi-level control function improves air flow and keeps the inside of the cab comfortable throughout the year.

## 2 X 12 V Power Outlets

The converter is increased in capacity and two power supply sockets are installed to supply electric power for various use.



## Auxiliary Input (MP3 Jack)

By connecting an auxiliary device such as an MP3 player to the auxiliary input, the operator can hear the sound through the speakers installed in the cab.



# SAFETY

## ROPS Cab (ISO 12117-2)

The machine is equipped with a ROPS cab that conforms to ISO 12117-2 for excavators as standard equipment. The ROPS cab has high shock absorption performance, featuring excellent durability and impact strength. It also satisfies the requirements of ISO OPG top guard level 1 for falling objects. Combined with the retractable seat belt, The ROPS cab protects the operator in case of tipping over and against falling objects.

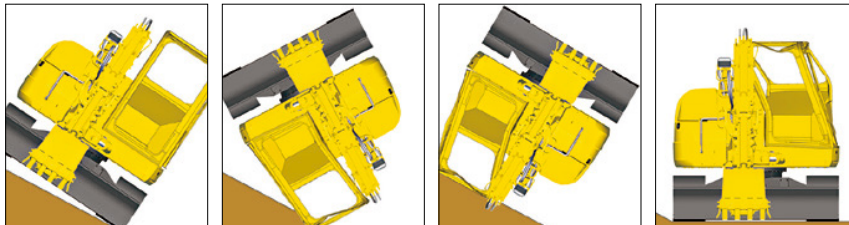

## Retractable Seat Belt

An easy-to-use retractable seat belt is standard.

## Travel Alarm

An alarm is installed as standard equipment to give other workers a warning when the machine travels forward or reverse.

## Lock Lever

When lock lever is placed in lock position all hydraulic controls (travel, swing, boom, arm and bucket) are inoperable.



Lever shown in lock position.

## Lock Lever Auto Lock Function

If the work equipment lever is not in the neutral position when the hydraulic lock lever is released, the equipment is automatically stopped. The auto stop state is shown on the monitor screen.



## Engine Shutdown Secondary Switch

A new secondary switch has been added to shutdown the engine.



## Emergency Escape Hammer

The cab is equipped with an emergency escape hammer for breaking the rear window glass in case of an emergency.



## Seat Belt Caution Indicator

Lights up when seat belt is not fastened.

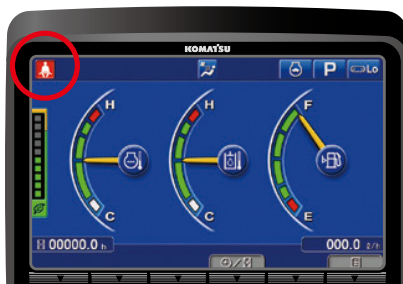

## Slip-resistant Plates

Highly durable slip-resistant plates maintain superior traction performance for the long term.

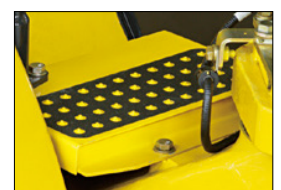



**Tempered and Tinted Glass**

The glass features high strength and blocks ultraviolet rays.

**Pump/engine Room Partition**

Pump/engine room partition shields oil from spraying on the engine if a hydraulic hose should burst.

**Handrails**

Handrails have been added on the upper structure of the machine. This provides additional convenience during hydraulic parts service.



**Wide Visibility**

Large cab and extended front glass enable operator to get better forward visibility.



**Rear View Monitoring System**

The operator can view the area behind the machine on a colour monitor screen.

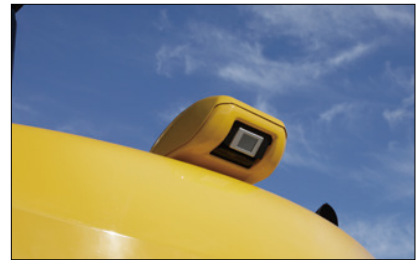

Rear view image on monitor.

**Skylight**

Skylight with window can be opened for overhead visibility.



# INFORMATION & COMMUNICATION TECHNOLOGY



## Large Multi-lingual High Resolution LCD Monitor

A large user-friendly high resolution LCD colour monitor enables safe, accurate and smooth work. Visibility and resolution are further improved compared with current 7-inch large TFT LCD. Simple and easy to operate switches. Function keys facilitate multi-function operations. Displays information and datas in 25 languages to globally support operators around the world.

### Indicators

- |                                  |                                   |
|----------------------------------|-----------------------------------|
| 1 Auto-decelerator               | 5 Hydraulic oil temperature gauge |
| 2 Working mode selector          | 6 Fuel gauge                      |
| 3 Traveling selector             | 7 ECO-gauge                       |
| 4 Engine water temperature gauge | 8 Fuel consumption gauge          |
|                                  | 9 Function switches menu          |

### Basic operation switches

- |                         |                     |
|-------------------------|---------------------|
| 1 Auto-decelerator      | 4 Buzzer cancel     |
| 2 Working mode selector | 5 Wiper             |
| 3 Traveling selector    | 6 Windshield washer |

## Supports Efficiency Improvement

The main screen displays recommendations for better energy-saving operations as needed. The operator can use the ECO guidance menu to check the operation records, ECO guidance records, average fuel consumption logs, etc.



ECO guidance



ECO guidance menu

## Operator Identification Function

An operator identification ID can be set for each operator, and used to manage operation information of individual machines as KOMTRAX data. Data sent from KOMTRAX can be used to analyse operation status by operator as well as by machine.



## Equipment Management Monitoring System (EMMS)

### Monitor Function

Controller monitors engine oil level, coolant temperature, battery charge air clogging, etc. If the controller detects an abnormality, it is displayed on the LCD.



### Maintenance Function

The monitor displays replacement time of oil and filters on the LCD when the replacement interval is reached.



### Trouble Data Memory Function

Monitor stores abnormalities for effective troubleshooting.

# KOMTRAX

## KOMTRAX

*Assists Customer's Equipment Management and Contributes to Fuel Cost Cutting*

### Equipment Management Support

KOMTRAX terminal installed on your machine collects and sends information such as machine location, working record, machine conditions, etc. using wireless communication. You can review the KOMTRAX data remotely via the online application. KOMTRAX not only gives you the power of knowledge on your machine, but also the convenience of managing your fleet on the web.

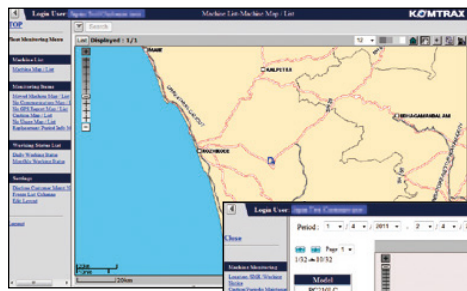
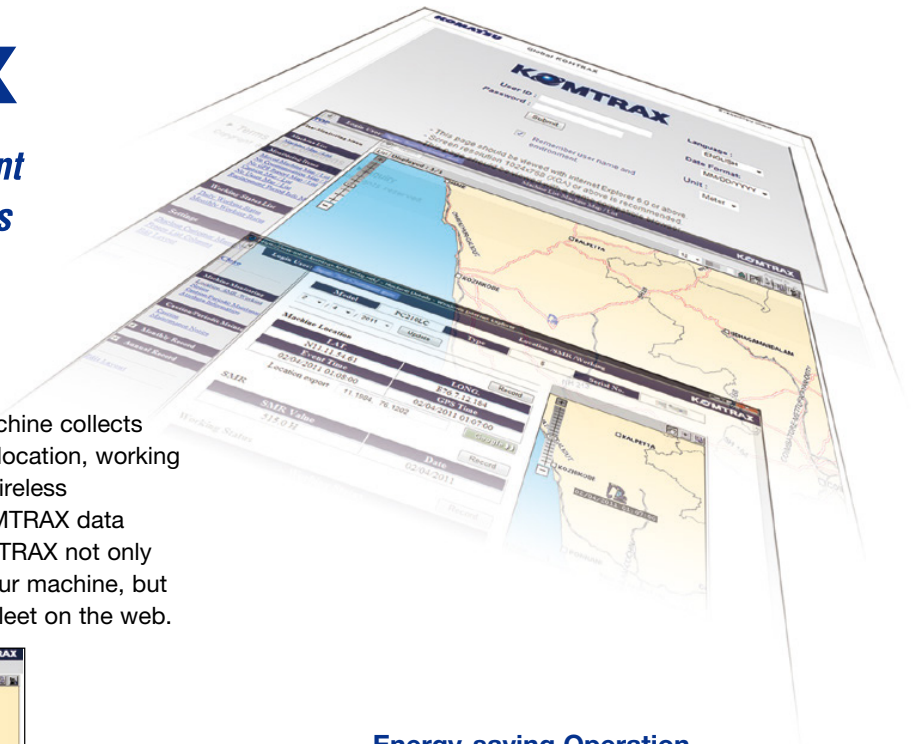

Location

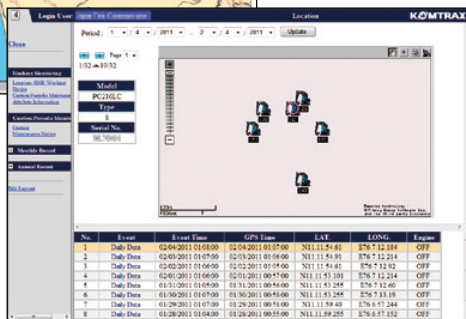

Movement generated position

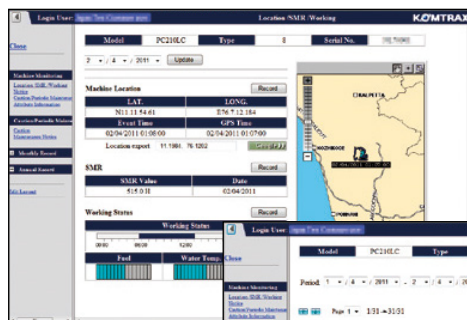

Operation map

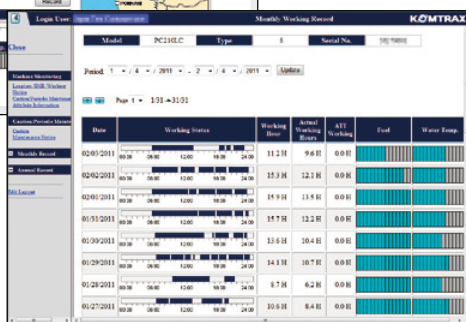

Monthly status summary

### Energy-saving Operation Support Report

KOMTRAX can provide various useful information which includes the energy-saving operation support report created based on the operating information of your machine such as fuel consumption and idle time.

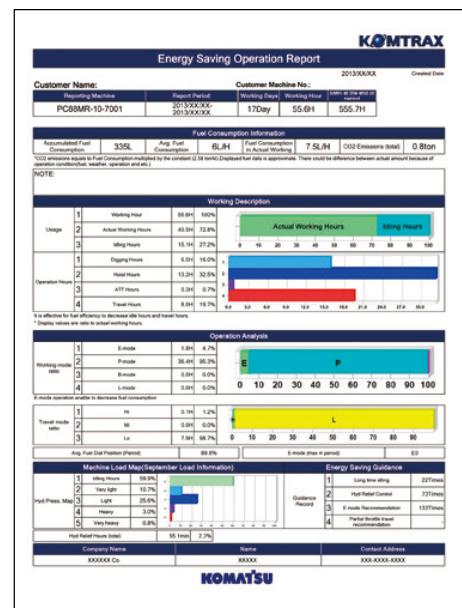

# MAINTENANCE FEATURES

## Optimum Maintenance Layout

With the engine hood, right side hood and side service doors, it is possible to access the major maintenance points from ground level. Furthermore, the fuel drain valve, engine oil filter and swing machinery oil filler are remote mounted, facilitating easy maintenance.

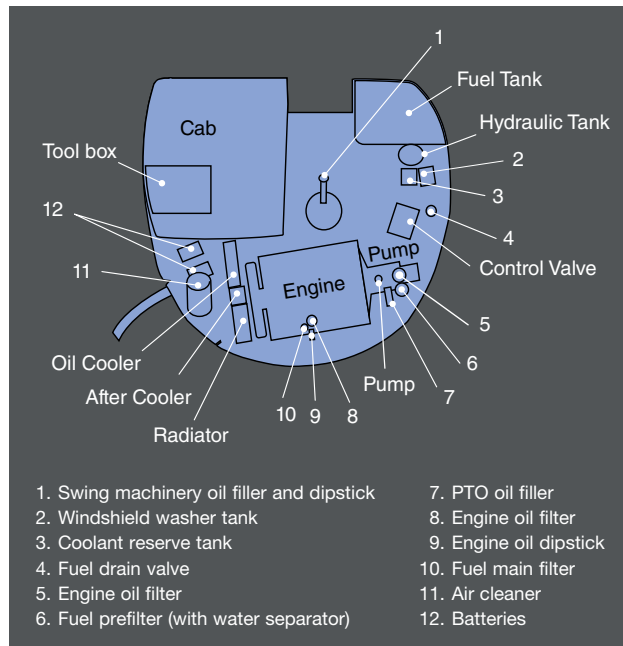

## Easy Access to Engine Oil Filter, Engine Main Fuel Filter and Fuel Drain Valve

Engine oil filter, engine main fuel filter and fuel drain valve are remote mounted to improve accessibility.



Fuel filter

## Equipped with the Fuel Prefilter (with Water Separator)

Removes water and contaminants in the fuel to prevent fuel problems. (with built-in priming pump)



Fuel prefilter with water separator



Engine oil filter



Fuel drain valve

## Fan Belt Auto-tensioner

You can service the fan belt easily.

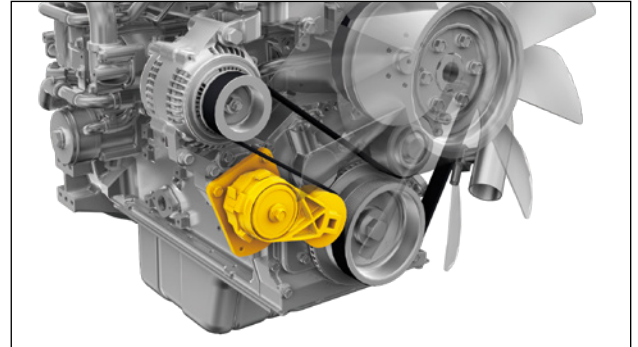

## Battery isolation switch

A standard battery isolation switch allows a technician to disconnect the power supply and lock out before servicing the machine.



## Air Conditioner Filter

The air conditioner filter is removed and installed without the use of tools facilitating filter maintenance.



External air conditioner filter

## Side-by-side Cooling

Since radiator, aftercooler and oil cooler are arranged in parallel, it is easy to clean, remove and install them. Radiator, aftercooler, and oil cooler made of aluminium have high cooling efficiency and are easily recycled.



## Washable Floor

The PC88MR-10's floor is easy to keep clean. The gently inclined surface has a flanged floor mat and drainage holes to facilitate run off.



**Large Tool Box**

Large tool box provides plenty of space. Grease pump storage space is also provided.



**Long Life Oils, Filters**

High performance filters are used in the hydraulic circuit and engine. By increasing the oil and filter replacement intervals, maintenance costs can be significantly reduced.

Engine oil & Engine oil filter	every <b>500</b> hours
Hydraulic oil	every <b>5000</b> hours
Hydraulic oil filter	every <b>1000</b> hours

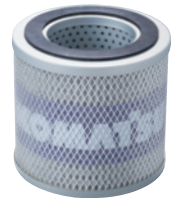

Hydraulic oil filter (Ecology-white element)



# SPECIFICATIONS



## ENGINE

Model .....Komatsu SAA4D95LE-6C  
 Type..... Water-cooled, 4-cycle, direct injection  
 Aspiration ..... Turbocharged, aftercooled, cooled EGR  
 Number of cylinders..... 4  
 Bore ..... **95 mm**  
 Stroke ..... **115 mm**  
 Piston displacement..... **3.26 ltr**  
 Horsepower:  
 SAE J1995 ..... Gross **50.7 kW** (68.0HP) / 1950 min<sup>-1</sup>  
 ISO 9249 / SAE J1349 .... Net **48.8 kW** (65.5HP) 1950 min<sup>-1</sup>  
 Governor .....All-speed control, electronic  
 Fan drive method for radiator cooling..... Mechanical  
 \*EPA Tier 4 and EU Stage 3B emissions certified



## HYDRAULICS

Type .....HydrauMind (Hydraulic Mechanical Intelligence New Design) system, closed-centre system with load-sensing valves and pressure-compensated valves  
 Number of selectable working modes ..... 6  
 Main pumps:  
 Pump for ..... Boom, arm, bucket and travel circuits  
 Type ..... Variable displacement, axial piston  
 Maximum flow..... **160 ltr/min**  
 Pump for ..... Swing and blade  
 Type ..... Fixed displacement gear  
 Maximum flow..... **70 ltr/min**  
 Hydraulic motors:  
 Travel..... 2 x piston motor with parking brake  
 Swing ..... 1 x piston motor with swing holding brake  
 Relief valve setting:  
 Implement circuits ..... **26.5 MPa 270 kgf/cm<sup>2</sup>**  
 Travel circuit..... **26.5 MPa 270 kgf/cm<sup>2</sup>**  
 Swing circuit ..... **21.1 MPa 215 kgf/cm<sup>2</sup>**  
 Pilot circuit ..... **3.2 MPa 33 kgf/cm<sup>2</sup>**  
 Blade circuit (Raise)..... **12.7 MPa 130 kgf/cm<sup>2</sup>**  
 (Lower)..... **21.1 MPa 215 kgf/cm<sup>2</sup>**  
 Hydraulic cylinders:  
 (Number of cylinders – bore x stroke x rod diameter)  
 Boom ..... **1-115 mm x 988 mm x 65 mm**  
 Arm ..... **1-100 mm x 861 mm x 60 mm**  
 Bucket ..... **1- 90 mm x 710 mm x 55 mm**  
 Boom swing..... **1-120 mm x 638 mm x 60 mm**  
 Blade..... **1-130 mm x 200 mm x 65 mm**



## DRIVES AND BRAKES

Steering control .....Two lever with pedals  
 Drive method.....Hydrostatic  
 Maximum drawbar pull ..... **66.9 kN 6820 kg**  
 Maximum travel speed:  
 High ..... **5.0 km/h**  
 Low ..... **2.8 km/h**  
 Service brake ..... Hydraulic lock  
 Parking brake .....Mechanical disc



## SWING SYSTEM

Driven by .....Hydraulic motor  
 Swing reduction .....Planetary gear  
 Swing circle lubrication.....Grease-bathed  
 Swing lock .....Mechanical disc brake  
 Swing speed ..... 10 min<sup>-1</sup>



## UNDERCARRIAGE

Centre frame .....X-frame  
 Track frame ..... Box-section  
 Seal of track ..... Sealed track  
 Track adjuster..... Hydraulic  
 Number of shoes (each side)..... 39  
 Number of carrier rollers (each side) ..... 1  
 Number of track rollers (each side)..... 5



## COOLANT & LUBRICANT CAPACITY (REFILLING)

Fuel tank..... **125 ltr**  
 Radiator..... **13 ltr**  
 Engine ..... **11.5 ltr**  
 Final drive, each side..... **1.1 ltr**  
 Swing drive..... **2.8 ltr**  
 Hydraulic tank ..... **56 ltr**



## OPERATING WEIGHT (APPROXIMATE)

Operating weight including **3,405 mm** one-piece boom, **1,650 mm** arm, SAE heaped **0.20 m<sup>3</sup>** backhoe bucket, blade, rated capacity of lubricants, coolant, full fuel tank, operator, and standard equipment.

Shoes	Operating Weight	Ground Pressure	
450 mm Road liner	<b>8,720 kg</b>	38.2 kPa	<b>0.39 kg/cm<sup>2</sup></b>
450 mm Triple grouser	<b>8,580 kg</b>	38.2 kPa	<b>0.39 kg/cm<sup>2</sup></b>
600 mm Triple grouser	<b>8,750 kg</b>	29.4 kPa	<b>0.30 kg/cm<sup>2</sup></b>
450 mm Rubber shoe	<b>8,500 kg</b>	37.3 kPa	<b>0.38 kg/cm<sup>2</sup></b>



## DIMENSIONS

	Boom Length	3405 mm	3405 mm
	Arm Length	1650 mm	2100 mm
<b>A</b>	Overall length	6255 mm	6430 mm
<b>B</b>	Overall height (to top of boom)	2240 mm	2615 mm
<b>C</b>	Overall width	2330 mm	
<b>D</b>	Overall height (to top of cab)	2760 / 2730* mm	
<b>E</b>	Ground clearance, counterweight	785 mm	
<b>F</b>	Ground clearance, minimum	410 mm	
<b>G</b>	Tail swing radius	1485 mm	
<b>H</b>	Track length on ground	2235 mm	
<b>I</b>	Track length	2890 / 2840* mm	
<b>J</b>	Track gauge	1870 mm	
<b>K</b>	Width of crawler	2320 mm	
<b>L</b>	Shoe width	450 mm	
<b>M</b>	Machine cab height	1885 mm	
<b>N</b>	Machine cab width	2330 mm	
<b>O</b>	Distance swing centre to rear end	1485 mm	

\*: Dimension of the machine with the triple grouser shoes.

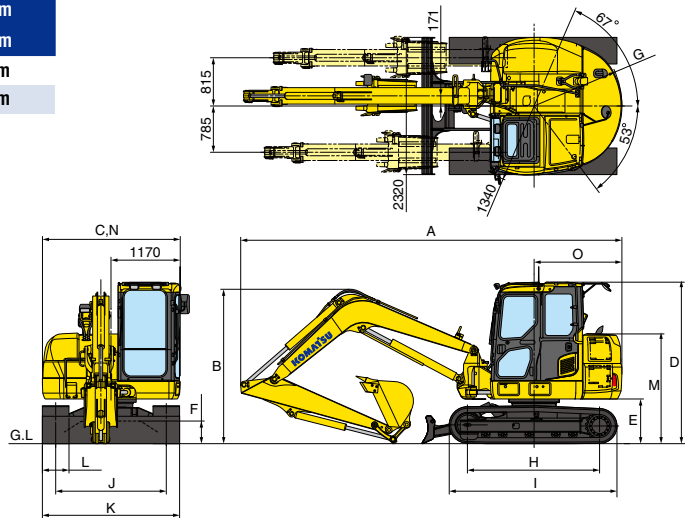

## WORKING RANGE

	Boom	3405 mm	3405 mm
	Arm	1650 mm	2100 mm
<b>A</b>	Maximum digging height	6620 mm	6800 mm
<b>B</b>	Maximum dumping height	4565 mm	4770 mm
<b>C</b>	Maximum digging depth	4110 mm	4565 mm
<b>D</b>	Maximum vertical wall digging depth	2850 mm	3115 mm
<b>E</b>	Maximum digging depth of cut for 2440 mm level	3715 mm	4200 mm
<b>F</b>	Maximum digging reach	6935 mm	7345 mm
<b>G</b>	Maximum digging reach at ground level	6710 mm	7135 mm
<b>H</b>	Minimum swing radius (When boom swing)	2755 mm (2395 mm)	2900 mm (2545 mm)
<b>ISO</b>	Bucket digging force	61.3 kN 6250 kg	61.3 kN 6250 kg
	Arm crowd force	41.5 kN 4230 kg	36.3 kN 3700 kg
<b>SAE</b>	Bucket digging force	53.3 kN 5440 kg	53.3 kN 5440 kg
	Arm crowd force	38.1 kN 3890 kg	34.3 kN 3500 kg

Short Arm

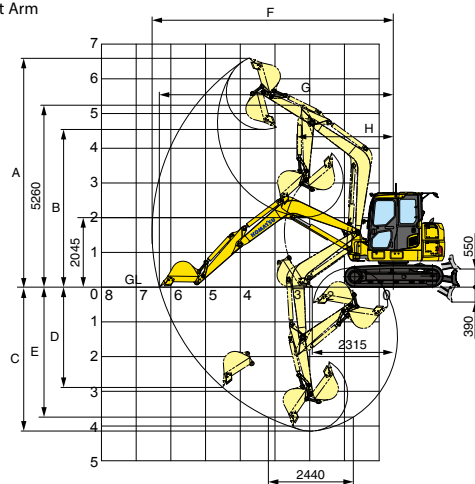

## BACKHOE BUCKET AND ARM COMBINATION

Bucket Capacity (heaped)		Width		Weight	Number of Teeth	Arm Length	
SAE, PCSA	CECE	Without Side Cutters	With Side Cutters			1650 mm	2100 mm
0.09 m <sup>3</sup>	0.08 m <sup>3</sup>	350 mm	450 mm	145 kg	3	○	○
0.12 m <sup>3</sup>	0.11 m <sup>3</sup>	450 mm	550 mm	160 kg	3	○	○
0.20 m <sup>3</sup>	0.18 m <sup>3</sup>	550 mm	650 mm	185 kg	3	○	○
0.28 m <sup>3</sup>	0.25 m <sup>3</sup>	650 mm	750 mm	210 kg	4	○	X
0.34 m <sup>3</sup>	0.30 m <sup>3</sup>	755 mm	N/A	210 kg	4	□	X

○ = General digging    □ = Light-duty operation    X = Not available

Long Arm

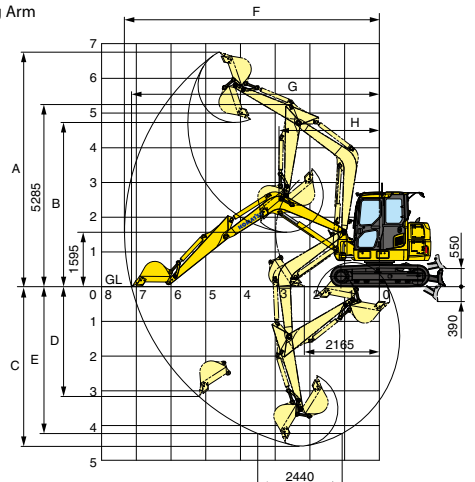

# LIFT CAPACITIES

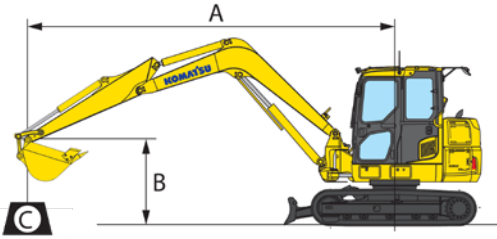

- A: Reach from swing centre
- B: Bucket hook height
- C: Lifting capacity
- Cf: Rating over front
- Cs: Rating over side
- ⊗: Rating at maximum reach

## CONDITION:

- Bucket: **0.20 m<sup>3</sup>** SAE heaped
- Arm length: **2100 mm**
- Shoe: **450 mm** Road liner
- Blade on ground

		⊗ MAX		4.5 m		3.0 m		1.5 m		Unit: kg
B	A	Cf	Cs	Cf	Cs	Cf	Cs	Cf	Cs	
5.0 m		*1310	1150							
3.0 m		*1430	780	*1420	*1420					
0.0 m		*1940	710	*2860	1200	*3980	2220			
-2.0 m		*2460	950	*3060	1170	*5440	2200	*4230	*4230	

## CONDITION:

- Bucket: **0.28 m<sup>3</sup>** SAE heaped
- Arm length: **1650 mm**
- Shoe: **450 mm** Road liner
- Blade on ground

		⊗ MAX		4.5 m		3.0 m		1.5 m		Unit: kg
B	A	Cf	Cs	Cf	Cs	Cf	Cs	Cf	Cs	
5.0 m		*1510	1370							
3.0 m		*1640	890	*1750	1410					
0.0 m		*2200	820	*3040	1230	*3520	2260			
-2.0 m		*2750	1160	*2950	1220	*5190	2290	*5370	*5370	

\*Load is limited by hydraulic capacity rather than tipping. Ratings are based on SAE Standard No. J1097. Rated loads do not exceed 87% of hydraulic lift capacity or 75% of tipping load.



## STANDARD EQUIPMENT

### ENGINE:

- Air cleaner, double element with auto dust evacuator
- Cooling fan, suction type

### ELECTRICAL SYSTEM:

- Alternator, 24 V/35 A
- Batteries, 2 x 12 V/55 Ah
- Starting motor 24 V/4.5 kW

### GUARDS AND COVERS:

- Fan guard
- Pump/engine partition cover
- Bolt-on top guard (operator protective guards level 2)

### HYDRAULIC SYSTEM:

- Auto deceleration
- Hydraulic control unit - 1 additional actuator

### OPERATOR ENVIRONMENT:

- 12 V x 2 power supply
- Auto air conditioner
- Auto idle shutdown
- Cab includes: antenna, AM/FM radio, floor mat, intermittent front windshield wiper and washer, large ceiling hatch, pull-up front window, removable lower windshield
- Handrails
- Lock lever auto lock function
- Monitor panel
- Operator identification function
- Rear view mirrors (LH, rear)
- ROPS cab (ISO 12117-2)
- Seat belt, 78 mm
- Rear view monitoring system

- OPG II fitted as standard
- Suspension seat
- Swing holding brake
- Travel alarm
- Working light on boom
- Working light on cab

### WORK EQUIPMENT:

- Arm — 1650 mm arm assembly
- Blade (Welded cutting edge type)
- Boom 3405 mm
- Window Tinting



## OPTIONAL EQUIPMENT

### GUARDS AND COVERS:

- Cab front guard
  - Full height guard (level 1)
  - Full height guard (level 2)

### ENGINE:

- Dustproof net for radiator, oil cooler, and after cooler

### WORK EQUIPMENT:

- Arm — 2100 mm arm assembly

### UNDERCARRIAGE:

- Shoes,
  - 450 mm triple grouser
- Track roller guard

www.Komatsu.com.au

Printed in Australia

# KOMATSU®